

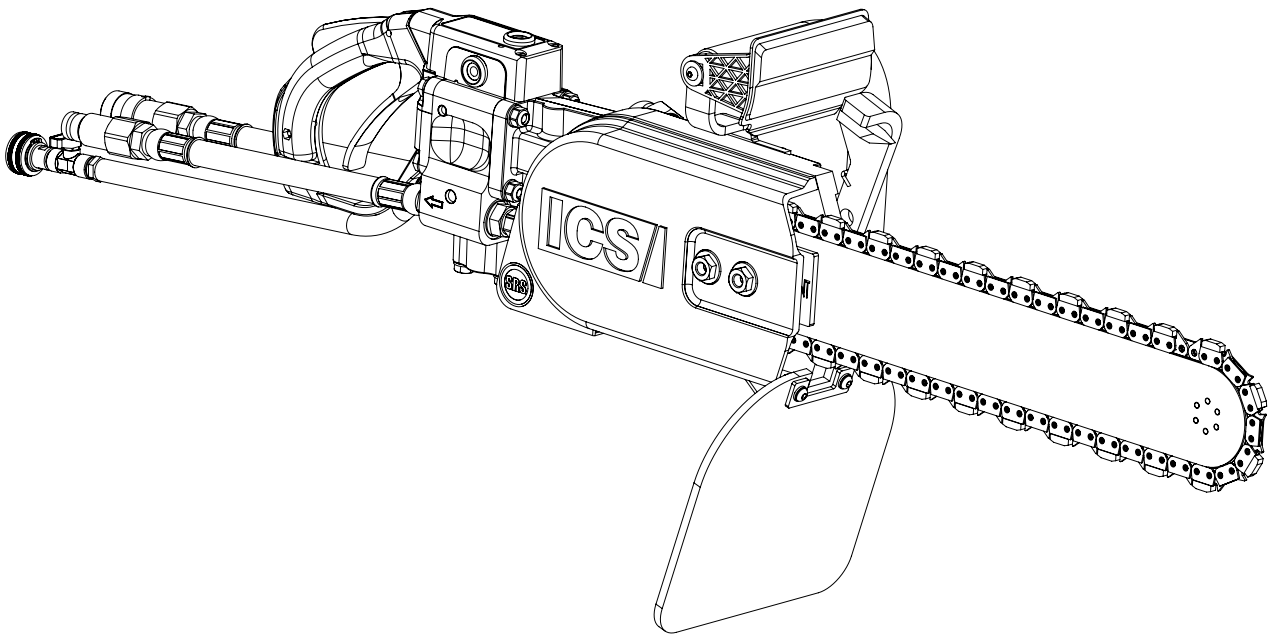

**Diamond Tools and Equipment
for Construction and Infrastructure**

Replacement Parts & Accessories Price List



880/890 Series Hydraulic Concrete Saw

Effective January 1, 2019

TABLE OF CONTENTS

880/890 Series Hydraulic Concrete Saw

ITEM DESCRIPTION	PAGE
880/890 Series Hydraulic Saw Service Parts & Kits	2
880/890 Series Hydraulic Saw Assembly	3 - 4

SERVICE PARTS & KITS

880/890 Series Hydraulic Concrete Saw

Part No.	Description	MSRP
70619	880/890 Series Tensioning Screws, Hydraulic Saws	\$13.75
71526	880/890 Series Hydraulic Valve Spool Kit	\$91.50
72296	880/890 Series Hydraulic Valve Seal Kit	\$29.50
72347	880/890 Series Hydraulic Trigger Lock-Out Spring & Pin Kit	\$25.25
506026	880/890 Series Hydraulic Trigger & Lock-Out Kit	\$41.20
507407	880/890 Series Hydraulic Front Handle Fastener Kit	\$13.70
518869	880/890 Series Hydraulic Water Valve Kit, includes clip, plunger, spring, ball & water bridge spindle	\$110.40
564961	880/890 Series Motor Conversion Kit 8 gpm (30 lpm) - includes drive sprocket/motor bolts	\$784.90
564960	880/890 Series Motor Conversion Kit 12 gpm (45 lpm) - includes drive sprocket/motor bolts	\$784.90
528594	880/890 Series Motor Seal Kit	\$178.70
564923	880/890 Series Shaft Conversion/Replacement Kit 8 gpm (30 lpm)	\$364.60
564924	880/890 Series Shaft Conversion/Replacement Kit 12 gpm (45 lpm)	\$364.60
540291	880/890 Series Side Cover Gasket	\$17.90
72342	880/890 Series Hydraulic Motor Bolt Kit	\$24.25
72344	880/890 Series Valve Bolt Kit	\$26.50
530046	880/890 Series FORCE4™ Bar Nose Sprocket Repair Kit	\$39.50
566059	880/890 Series Water Shut-off Valve Kit	\$69.50

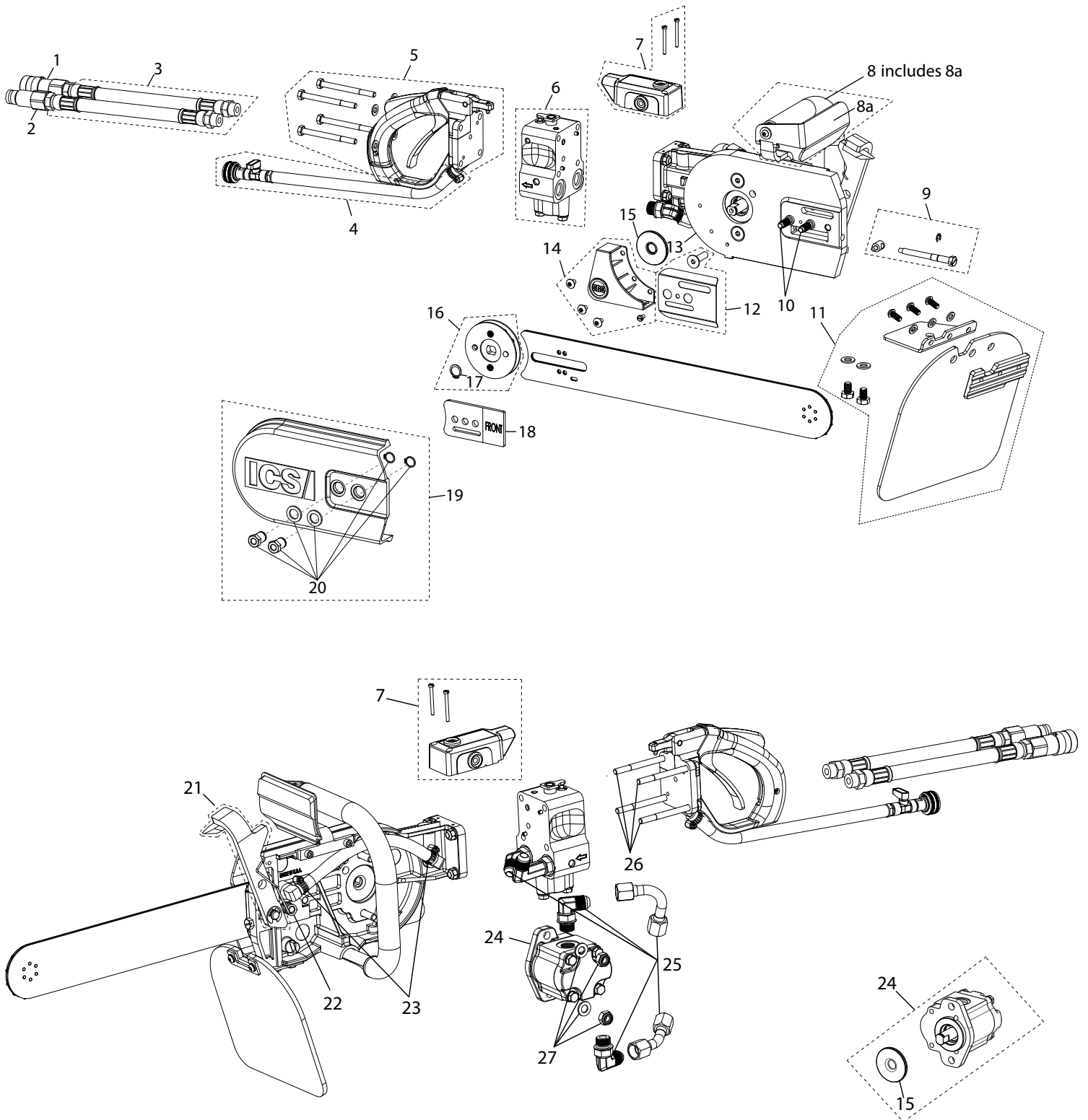

Key #	Part No.	Description	MSRP
1	71916	880/890 Series QD, Female, with O-Ring, Kit (hose not included)	\$86.25
2	71917	QD Male with O-Ring (hose not included)	\$51.50
3	70629	880/890 Series Hydraulic Pigtail Kit 1' hoses (set of 2 hoses, QD's included)	\$161.00
3	566556	880/890 Series Hydraulic Hose Whip 8' (one hose only, does not include Quick Disconnects) Not shown	\$95.70
4	566059	880/890 Series Water Shut-off Valve Kit	\$69.50
5	565316	880/890 Series Rear-Handle Replacement Kit	\$230.20
6	528553	880/890 Series Hydraulic Valve Replacement	\$600.00
7	565317	880/890 Series Valve Cover Kit with levels, Black	\$128.50
8	71153	880/890 Series Front Handle Kit (includes 8a) - 8gpm (30 lpm)	\$169.25
8a	74586	880/890 Series Front Hand guard Kit - 8 gpm (30 lpm)	\$39.75
8	71536	880/890 Series Front Handle Kit (includes 8a) - 12gpm (45 lpm)	\$169.25
8a	517874	880/890 Series Front Hand guard Kit - 12 gpm (45 lpm)	\$38.90
9	70636	880/890 Series Tensioner Kit	\$65.25
10	72349	880/890 Series Series Bar Mounting Studs	\$64.25
11	576336	880/890 Series Series Mud Flap Assembly	\$112.00
12	70627	880/890 Series Bar Mount Cover Plate	\$24.25
13	528562	880/890 Series Main Frame	\$365.70
14	512592	Baffle Drain Replacement Kit	\$92.50
15	528563	880/890 Series External Shaft Seal Kit	\$61.00
16	565065	880/890 Series Drive Sprocket (includes snap ring)	\$236.90
17	549796	880/890 Series Snap Ring Kt	\$5.30
18	70628	880/890 Series Bar Retaining Plate	\$34.75
19	528564	880/890 Series Side Cover Replacement Kit	\$204.90
20	70639	880/890 Series Cover Retaining Nuts (set of 2)	\$57.00
21	70641	880/890 Series WallWalker Replacement Kit	\$241.75
22	70640	880/890 Series WallWalker Spring	\$22.25
23	72346	Front Water Hose Kit	\$26.50
24	564962	880/890 Series Hydraulic Motor Replacement Kit - 8 gpm (30 lpm)	\$616.80
24	564983	880/890 Series Hydraulic Motor Replacement Kit - 12 gpm (45 lpm)	\$616.80
25	532400	880/890 Series Hydraulic Plumbing Replacement Kit	\$94.60
26	72344	880/890 Series Valve Bolt Kit	\$26.50
27	72342	880/890 Series Motor bolt kit (x2)	\$24.25

880/890 Series Replacement Parts & Accessories Price List

**ICS, Blount Inc.
4909 SE International Way
Portland, OR 97222
Tel 800.321.1240
icsdiamondtools.com**